

PS2-150 C-SJ5-8

Solar Submersible Pump System for 4" wells

System Overview

Head	max. 20 m
Flow rate	max. 4,6 m³/h

Technical Data

Controller PS2-150

- Controlling and monitoring
- Control inputs for dry running protection, remote control etc.
- Protected against reverse polarity, overload and overtemperature
- Integrated MPPT (Maximum Power Point Tracking)
- Battery operation: Integrated low voltage disconnect

Power	max. 0,30 kW
Input voltage	max. 50 V
Optimum Vmp**	> 17 V
Motor current	max. 22 A
Efficiency	max. 98 %
Ambient temp.	-40...50 °C
Enclosure class	IP68

Motor ECDRIVE 150-C

- Maintenance-free brushless DC motor
- Water filled
- Premium materials, stainless steel: AISI 304/316
- No electronics in the motor

Rated power	0,3 kW
Efficiency	max. 92 %
Motor speed	600...3.300 rpm
Insulation class	F
Enclosure class	IP68
Submersion	max. 150 m

Pump End PE C-SJ5-8

- Non-return valve
- Premium materials, stainless steel: AISI 304
- Optional: dry running protection
- Centrifugal pump

Efficiency	max. 51 %
------------	-----------

Pump Unit PU150 C-SJ5-8 (Motor, Pump End)

Borehole diameter	min. 4,0 in
Water temperature	max. 50 °C

Standards



2006/42/EC, 2004/108/EC, 2006/95/EC

IEC/EN 61702:1995

The logos shown reflect the approvals that have been granted for this product family. Products are ordered and supplied with the approvals specific to the market requirements.

**Vmp: MPP-voltage under Standard Test Conditions (STC): 1000 W/m² solar irradiance, 25 °C cell temperature



PS2-150 C-SJ5-8

Solar Submersible Pump System for 4" wells

Pump Chart

Vmp* > 17 V

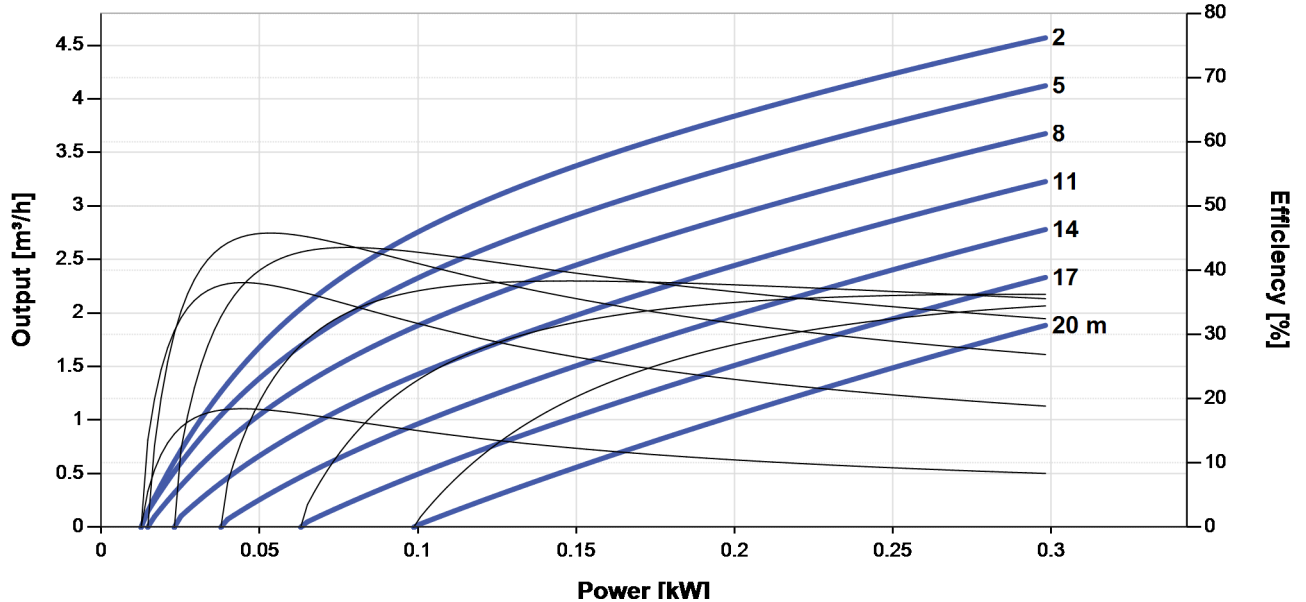

Dimensions and Weights

Controller

- H1 = 352 mm
- H2 = 333 mm
- W1 = 207 mm
- W2 = 170 mm
- W3 = 164 mm
- D1 = 124 mm

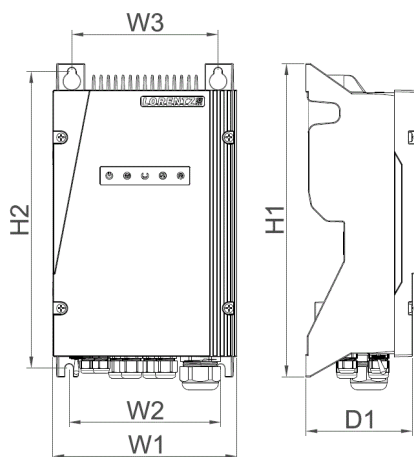

Pump Unit

- A = 524 mm
- B = 185 mm
- C = 339 mm
- D = 96 mm
- E = 98 mm
- S = 1,5 in

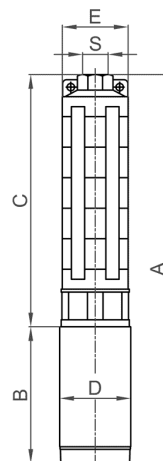

	Net weight
Controller	5,6 kg
Pump Unit	11 kg
Motor	7,0 kg
Pump End	4,2 kg

*Vmp: MPP-voltage under Standard Test Conditions (STC): 1000 W/m² solar irradiance, 25 °C cell temperature

